

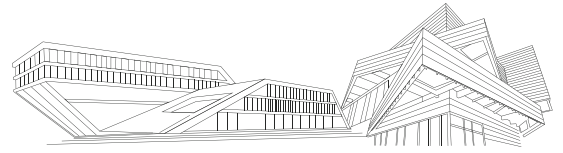

TREYLER PROFİLLERİ

TRAILER PROFILE





TREYLER PROFİLLERİ
TRAILER PROFILE

- 39-933
- 75'lik Bisikletlik
- 0.837 Kg/m

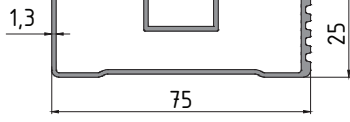

- 39-934
- 100'lük Bisikletlik
- 1.059 Kg/m

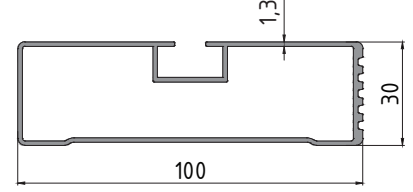

- 39-948
- 100'lük Bisikletlik
- 1.563 Kg/m

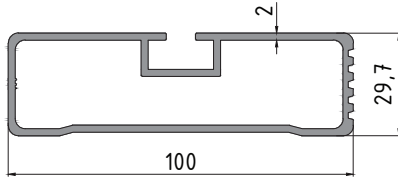

- 39-935
- 100'lük Tahtalık
- 1.007 Kg/m

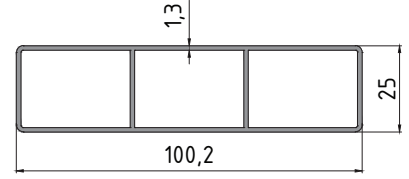

- 39-936
- 100'lük Tahtalık
- 1.435 Kg/m

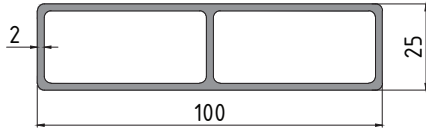

- 39-946
- 120'lik Tahtalık
- 1.066 Kg/m

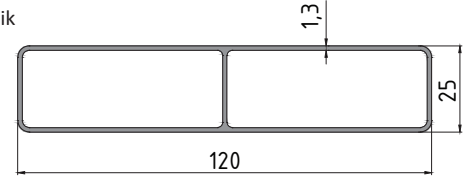

- 39-956
- V Tahtalık
- 1.259 Kg/m

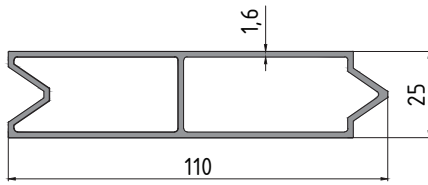

- 39-942
- Bisikletlik Dönüş
- 0.887 Kg/m

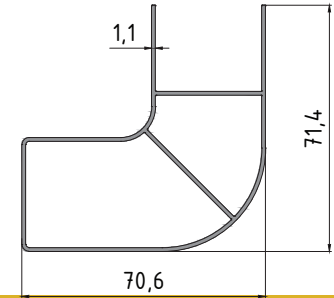

- 39-947
- Bisikletlik Dönüş
- 1.534 Kg/m

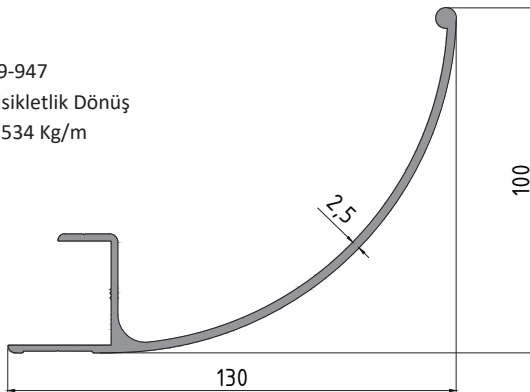

- 39-930
- 50x90 Kaş Profili
- 0.911 Kg/m

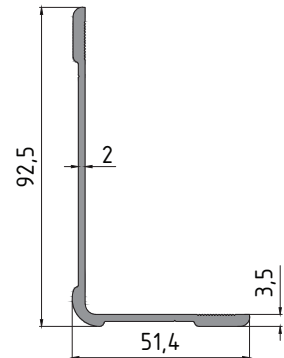

- 39-939
- 100x100 Kaş Profili
- 1.329 Kg/m

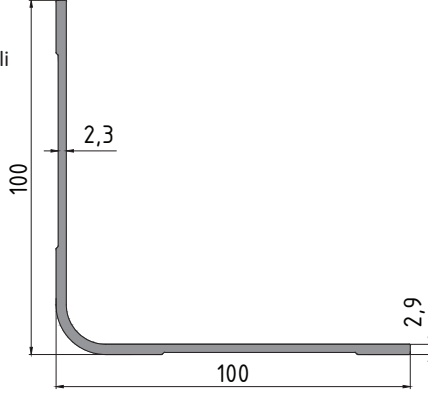

- 39-953
- 100x100 Kaş Profili
- 1.360 Kg/m

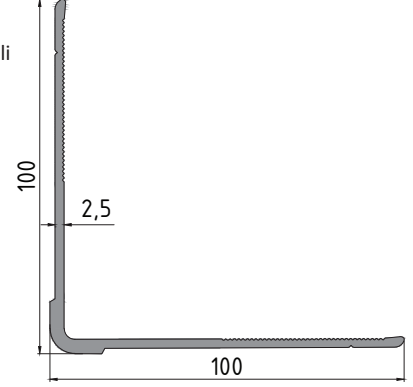

- 39-940
- Köşebet
- 1.284 Kg/m

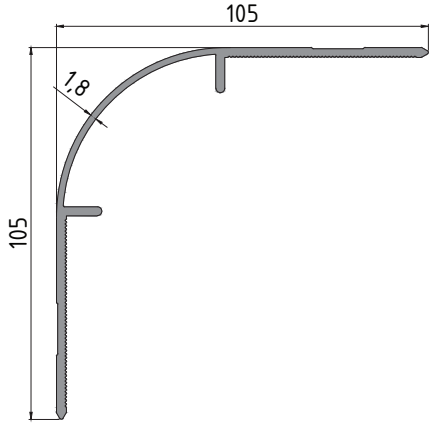

- 39-941
- T Ray
- 1.300 Kg/m

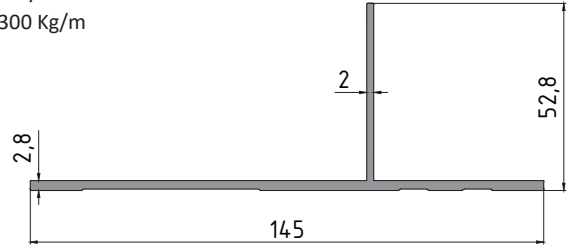

- 39-952
- T Profil
- 1.232 Kg/m

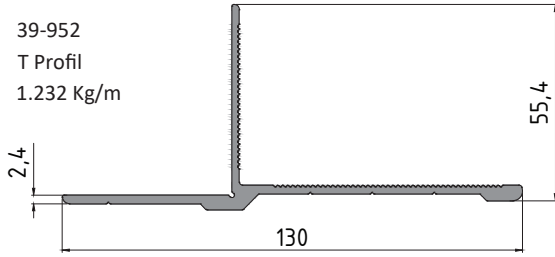

- 39-949
- Kapi Yan Kilit
- 1.398 Kg/m

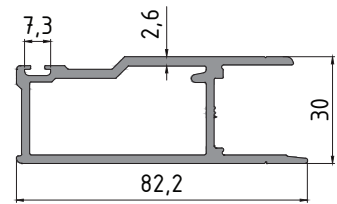

- 39-401
- Kasa Kilit Profili
- 1.405 Kg/m

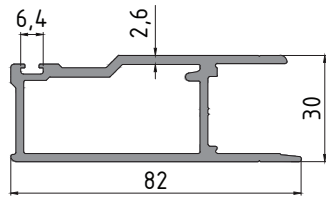

- 39-951
- Süpürgelik
- 0.638 Kg/m

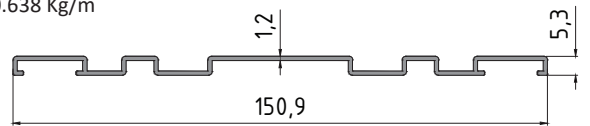

- 39-959
- Tutucu Ray
- 3.117 Kg/m

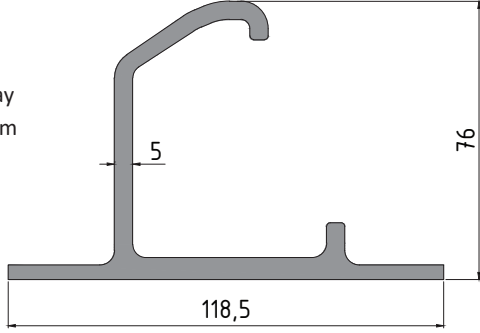

- 39-955
- Ray Profili
- 2.425 Kg/m

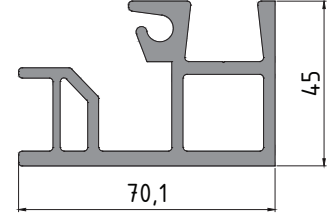

- 39-958
- Ray
- 1.695 Kg/m

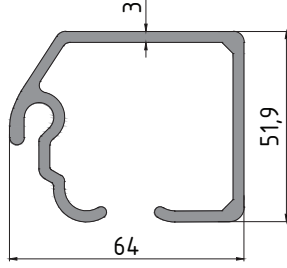

- 39-963
- Hareketli Tirnak
- 2.404 Kg/m

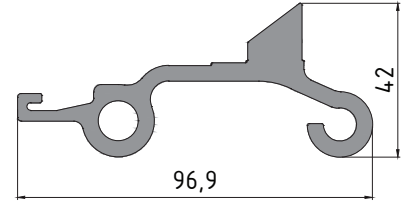

- 39-944
- Alüminyum Boru
- 1.119 Kg/m

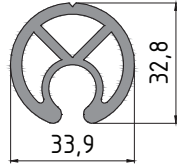

- 39-945
- Alüminyum Boru
- 0.632 Kg/m

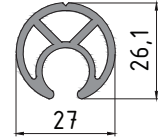

- 39-943
- Boru Tutamak
- 0.877 Kg/m

