



BEST
OF
THE
BEST
NOR

www.noraluminyum.com.tr

PROFİL
VE AKSESUAR
KATALOĞU

PROFILE AND ACCESSORIES
CATALOGUE

+90 549 502 03 30
+90 552 863 37 13

info@noraluminyum.com.tr

Burhan Osb. Mah. 16. Cad. No:3
Akdeniz/MERSİN



HAKKIMIZDA/ABOUT US

Nor Alüminyum, müşterilerine hizmet verdiği ilk günden bu yana müşteri memnuniyeti ve sürdürülebilirlik faaliyetlerini kalite prensibi haline getirmiştir. Alüminyum sektöründe 20 yıllık tecrübemizle, hassas profilleri üretme yetkinliğine sahibiz. Mekanik işleme departmanından üretim tesislerine kadar tam entegre bir tesisimizin yanı sıra eloksaldan statik boyahanesine kadar müşterilerimizin her türlü alüminyum ekstrüzyon ihtiyacını karşılamaya hazırız.

Nor Aluminum has made customer satisfaction and sustainability core quality principles since the first day it began serving its customers. With 20 years of experience in the aluminum industry, we have the capability to produce high-precision profiles. In addition to our fully integrated facility—from the mechanical machining department to production plants—we are ready to meet all aluminum extrusion needs of our customers, from anodizing to electrostatic powder coating.

MİSYONUMUZ/OUR MISSION

Misyonumuz, müşterilerimize ve çözüm ortaklarımıza faaliyet alanımız çerçevesinde ihtiyaç duyduğu tüm ürün ve hizmeti uluslararası düzeyde kabul gören kalite standartlarını sağlayarak uluslararası pazarda itibarlı ve istikrarlı büyüme sağlamaktır. Bu misyonu ülkemizin ekonomik stratejileri ve menfaatleri doğrultusunda kullanarak ülke içinde, sektöründe lider firmalardan biri olmanın haklı onurunu yaşamak ve yaşatmaktır.

Our mission is to provide our customers and solution partners with all the products and services they require within the scope of our operations, in full compliance with internationally recognized quality standards, and to achieve reputable and sustainable growth in the international market. By pursuing this mission in line with our country's economic strategies and interests, we aim to earn and uphold the well-deserved pride of being one of the leading companies in our sector domestically.







VİZYONUMUZ/OUR VISION

Sürdürülebilir toplam kalite felsefesini ilke edinerek, alanında küresel pazarda lider olmayı kendine hedef alan firmamız, sürekli iyileştirmeler ile müşterilerine çözüm odaklı ve yenilikçi hizmetler sunma vizyonunu hedef edinmiştir.

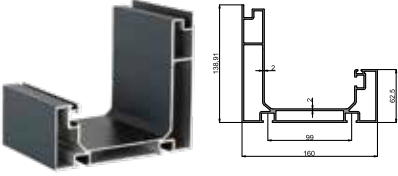
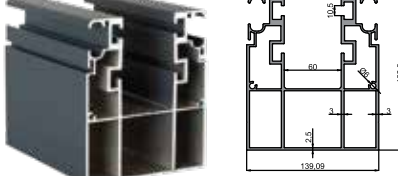
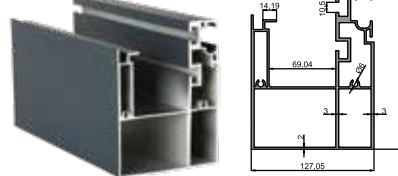
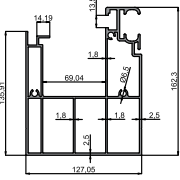
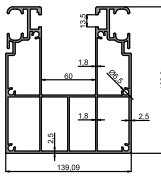
By adopting the philosophy of sustainable total quality as a core principle and setting its sights on global market leadership in its field, our company has embraced a vision of delivering solution-oriented and innovative services to its customers through continuous improvement.

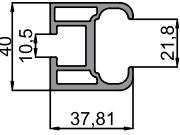
BIOKLİMATİK & ROLLING ROOF PROFİL LİSTESİ

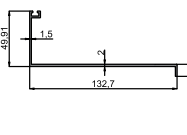
/ BIOCLIMATIC & ROLLING ROOF PROFILE LIST

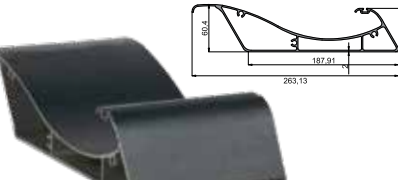
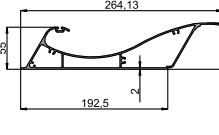
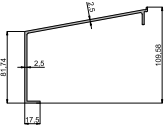
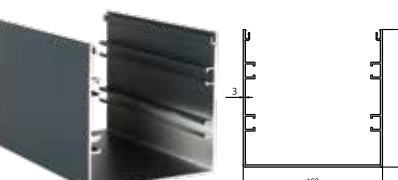
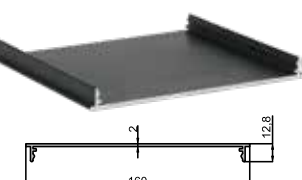
 <ul style="list-style-type: none">• 10-10949• Oluk Profili / Gutter Profile• 4.241 kg/m	 <ul style="list-style-type: none">• 10-10947• Çiftli Ray Profili / Double Sided Rail Profile• 8.792 kg/m	 <ul style="list-style-type: none">• 10-10948• Tekli Ray Profili / Single Sided Rail Profile• 6.627 kg/m
 <ul style="list-style-type: none">• 10-10987• Tekli Ray Profili / Single Sided Rail Profile• 6.217 kg/m	 <ul style="list-style-type: none">• 10-10988• Çiftli Ray Profili / Double Sided Rail Profile• 7.336 kg/m	 <ul style="list-style-type: none">• 10-10950• Oluk ve Ray Üst Profili / Gutter and Rail Top Profile• 1.394 kg/m
 <ul style="list-style-type: none">• 10-10951• Hareketli Ray Profili / Moving Rail Profile• 1.251 kg/m	 <ul style="list-style-type: none">• 10-10952• İç Oluk / Inner Gutter• 1.467 kg/m	 <ul style="list-style-type: none">• 10-10957• İç Oluk / Inner Gutter• 1.012 kg/m
 <ul style="list-style-type: none">• 10-10981• Led Kanal Profili / Led Duct Profile• 0.651 kg/m	 <ul style="list-style-type: none">• 10-10953• Panel Profili / Panel Profile• 3.658 kg/m	 <ul style="list-style-type: none">• 10-10944• Panel Profili / Panel Profile• 3.490 kg/m
 <ul style="list-style-type: none">• 10-10956• Motor Kapak Profili / Engine Cover Profile• 1.691 kg/m	 <ul style="list-style-type: none">• 10-10955• Ayak Profili / Counterfort Profile• 4.423 kg/m	 <ul style="list-style-type: none">• 10-10954• Ayak Kapak Profili / Counterfort Cover Profile• 1.007 kg/m

BİRLEŞİM MODÜLLERİ /CONNECTION MODULES

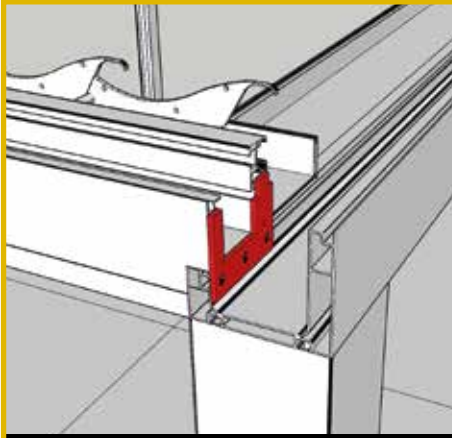

TEKLİ RAY ÖN LAZER MONTAJ DETAYI
SINGLE RAIL FRONT LASER MOUNTING DETAIL

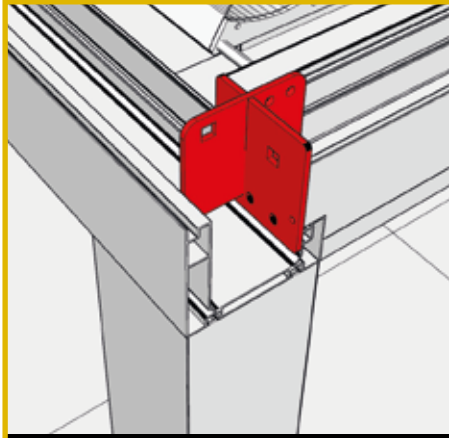

TEKLİ RAY ARKA LAZER MONTAJ DETAYI
SINGLE RAIL REAR LASER MOUNTING DETAIL

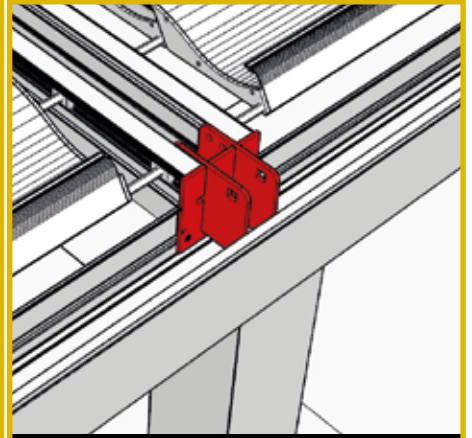

ÇİFTLİ RAY ARKA LAZER MONTAJ DETAYI
DOUBLE RAIL REAR LASER MOUNTING DETAIL

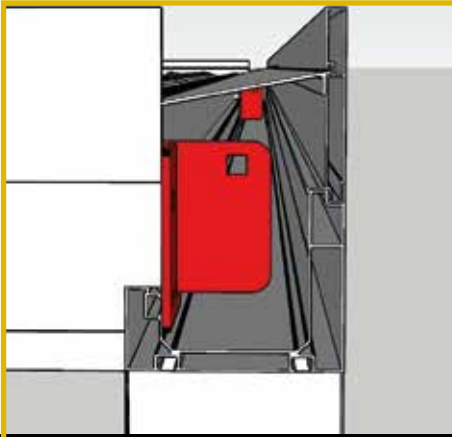

MOTOR LAZERİ MONTAJ DETAYI
MOTOR LASER ASSEMBLY DETAIL

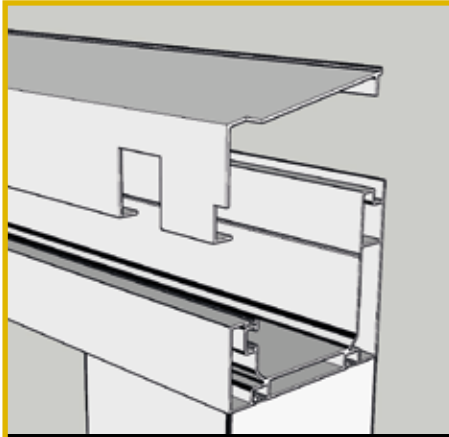

MOTOR KAPAĞI KERTME DETAYI
ENGINE COVER NOTCH DETAIL



ÇİFTLİ RAY BİRLEŞME DETAYI
DOUBLE RAIL INTERCONNECTION DETAIL

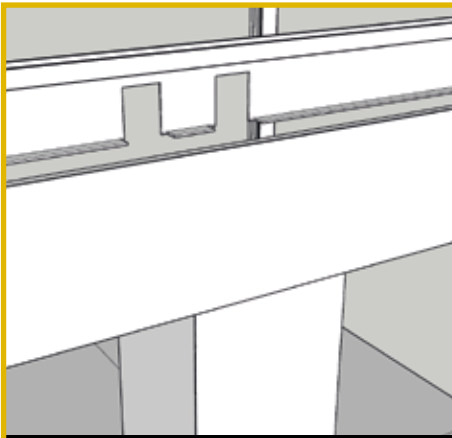

MOTOR KAPAĞI ÇİFTLİ RAY KERTME DETAYI
ENGINE COVER DOUBLE RAIL NOTCH DETAIL

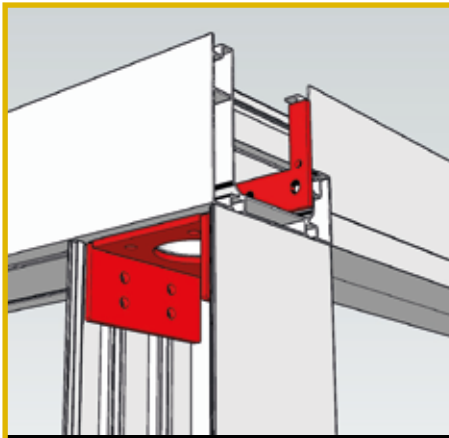

AYAK OLUK BİRLEŞME DETAYI
FOOT GROOVE JOINING DETAIL

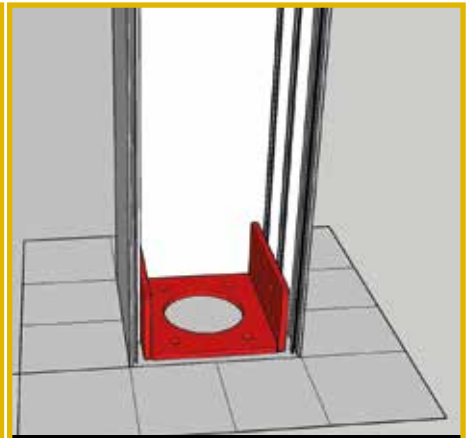

AYAK ZEMİN MONTAJ DETAYI
FOOT FLOOR MOUNTING DETAIL



153.01.0045

Bio. Aks. Oluk Altı Taşıyıcı
Bio. Axle. Gutter Bottom Support
BİOKLİMATİK-ROLLİNG-TİLT



153.01.0145

Bio. Aks. Oluk Yan Kapak (10953)
Bio. Axle. Gutter Side Cover (10953)
BİOKLİMATİK-ROLLİNG-TİLT

153.01.0152

**Bio. Aks. Oluk Birleştirme
Aparatı (10953)**
Bio. Axle. Gutter Joining Device (10953)
BİOKLİMATİK-ROLLİNG-TİLT



153.01.0006

**Bio. Aks. Arka Triger Sabitleme
Yön Makarası**
Bio. Axle. Rear Trigger Fixing Guide Roller
BİOKLİMATİK-ROLLİNG-TİLT



153.01.0008

Bio. Aks. Teker Tutucu (4 mm)
Bio. Axle. Wheel Holder (4 mm)
BİOKLİMATİK-ROLLİNG-TİLT



153.01.0138

**Bio. Aks. 160x160xmm
Ayak Üst (10953)**
Bio. Axle. 160x160xmm Foot Top (10953)
BİOKLİMATİK-ROLLİNG-TİLT



153.01.0148

**Bio. Aks. 160x160xmm
Ayak Alt (10953)**
Bio. Axle. 160x160xmm Foot Bottom (10953)
BİOKLİMATİK-ROLLİNG-TİLT



153.01.0108

Bio. Aks. Oluk İçi Parça
Bio. Axle. Gutter Interior Part
BİOKLİMATİK-ROLLİNG-TİLT

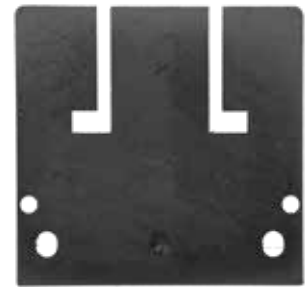

153.01.0157

**Bio. Aks. Çiftli ray dış oluk
sabitleme aparatı (kapalı) (10953)**
Bio. Axle. Double rail external groove
fixing device (closed) (10953)
BİOKLİMATİK-ROLLİNG-TİLT

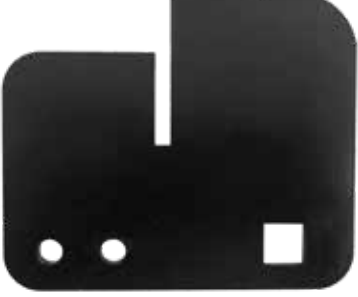

153.01.0153

Bio.AKS. Motor kulak aparatı (10953)

Bio. Axle. Motor ear device (10953)
BİOKLİMATİK-ROLLİNG-TİLT

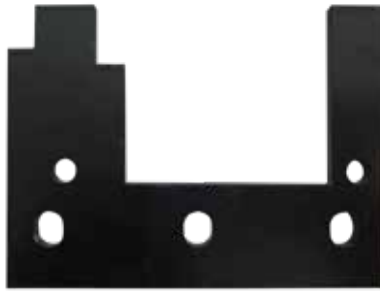

153.01.0154

Bio.AKS. Tekli ray dış oluk sabitleme aparatı (açık) (10953)

Bio. Axle. Single rail external groove fixing device (open) (10953)
BİOKLİMATİK-ROLLİNG-TİLT

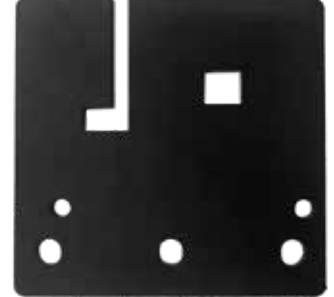

153.01.0155

Bio.AKS. Tekli ray dış oluk sabitleme aparatı (kapalı) (10953)

Bio. Axle. Single rail external groove fixing device (closed) (10953)
BİOKLİMATİK-ROLLİNG-TİLT



153.01.0156

Bio. AKS. ÇİFTLİ ray dış oluk sabitleme aparatı (açık) (10953)

Bio. Axle. Double rail external groove fixing device (open) (10953)
BİOKLİMATİK-ROLLİNG-TİLT



153.01.0139

Bio. Aks. Panel Yan Lazer (10953)

Bio. Axle. Panel Side Lazer (10953)
BİOKLİMATİK-ROLLİNG-TİLT



153.01.0044

Bio. Aks. Kıl Fıtıl 6,7 mm (Finli) 1000 Siyah

Bio. Axle. Wax Wick 6.7 mm (Finnish) 1000 Black
BİOKLİMATİK-ROLLİNG-TİLT



153.01.0043

Bio. Aks. Bioklimatik Contası (NOR1)

Bio. Axle. Bioclimatic Gasket (NOR1)
BİOKLİMATİK-ROLLİNG-TİLT



153.01.1064

Bio. Aks. Led Kapağı (8 m)

Bio. Axle. LED Cover (8 m)
BİOKLİMATİK-ROLLİNG-TİLT



153.01.0118

Bio. Aks. Şerit Led

Bio. Axle. Strip LED
BİOKLİMATİK-ROLLİNG-TİLT



153.01.1071

Aks. Kumanda
Axle. Control
BİOKLİMATİK-ROLLİNG-TİLT



153.01.0121

Bio. Aks.Orta Taşıyıcı Teker
Bio. Axle. Centre Carrier Wheel
BİOKLİMATİK-ROLLİNG-TİLT

153.01.0122

Bio. Aks.Strafor Köpük
Bio. Axle. Foam
BİOKLİMATİK-ROLLİNG-TİLT



153.01.0140

Bio. Aks. Kaldıraç (10953)
Bio. Axle. Lever (10953)
BİOKLİMATİK-TİLT



153.01.0005

Bio. Aks. Piston Alt Sabitleme Lazeri (4 mm)
Bio. Axle. Piston Bottom Fixing Laser (4 mm)
BİOKLİMATİK-TİLT



153.01.0136

Bio. Aks. Teker 84 mm
Bio. Axle. Wheel 84 mm
BİOKLİMATİK-TİLT



153.01.1040

Bio. Aks. M10 Somun Küçük
Bio. Axle. M10 Small Nut
BİOKLİMATİK-TİLT



153.01.1075

Bio. Aks. Piston Tutucu (Piston Mili)
Bio. Axle. Piston Holder (Piston Shaft)
BİOKLİMATİK-TİLT



153.01.0009

Bio. Aks. M10 Somun
Bio. Axle. M10 Nut
BİOKLİMATİK-TİLT



153.01.0053

Bio. Aks. Çelik Halat
Bio. Axle. Steel Cable
BİOKLİMATİK-TİLT



153.01.0041

Bio. Aks. Sekizgen Milli Boru Başı
Bio. Axle. Octagonal Pipe Head
BİOKLİMATİK-ROLLİNG



153.01.0040

Bio. Aks. Plastik Triger Dişli
Bio. Axle. Plastic Trigger Gear
BİOKLİMATİK-ROLLİNG

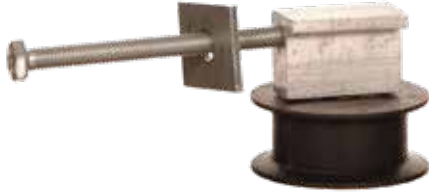

153.01.0037

Bio. Aks. Ön Germe Takımı
Bio. Axle. Front Tensioning Kit
BİOKLİMATİK-ROLLİNG



153.01.0038

Bio. Aks. Triger Kitleme
Bio. Axle. Trigger Locking
BİOKLİMATİK-ROLLİNG



153.01.0039

Bio. Aks. Arka Gergi Makarası
Bio. Axle. Rear Tension Pulley
BİOKLİMATİK-ROLLİNG



153.01.0061

Bio. Aks. Kayış / 16 mm Açık Uçlu Siyah
Bio. Axle. Belt / 16 mm Open End Black
BİOKLİMATİK-ROLLİNG



153.01.0119

Bio. Aks. Linear Motor (Piston)
Bio. Axle. Linear Motor (Piston)
BİOKLİMATİK-ROLLİNG



153.01.1083

Bio. Aks. Cuppon Motor (Alicısız)
Bio. Axle. Cuppon Motor (Receiverless)
BİOKLİMATİK



153.01.1004

Bio. Aks. Elektrik Panosu
Bio. Axle. Electrical Panel
BİOKLİMATİK



153.01.0142

Bio. Aks. Küçük Makas (10953)
Bio. Axle. Small Scissors (10953)
ROLLING



153.01.0141

Bio. Aks. Büyük Makas (10953)
Bio. Axle. Big Scissors (10953)
ROLLING



153.01.1079

Bio. Aks. Rolling Teker
Bio. Axle. Rolling Wheel
ROLLING



153.01.1080

Bio. Aks. Rolling Vida
Bio. Axle. Rolling Screw
ROLLING



153.01.1088

Bio. Aks. Rolling Pul
Bio. Axle. Rolling Washer
ROLLING



153.01.1094

Aks. Cuppon Motor (Alicılı)
Axle. Coupon Motor (with Receiver)
ROLLING



153.01.1105

Bio. Aks. Piston Motor Kartı 220 V
(Tek Hareket)
Bio. Aks. Piston Motor Board 220 V
(Single Action)
TILT

SAHADAN ÖRNEK FOTOĞRAFLARIMIZ
/SAMPLE PHOTOS FROM THE FIELD



SERTİFİKALARIMIZ/OUR CERTIFICATES





BEST
OF
THE
BEST
NOR

+90 549 502 03 30
+90 552 863 37 13



info@noraluminyum.com.tr

Burhan Osb. Mah. 16. Cad. No:3
Akdeniz/MERSİN